

FDV 1003 MECHANICAL EARTQUAKE VALVE

4" Flanged Horizontal

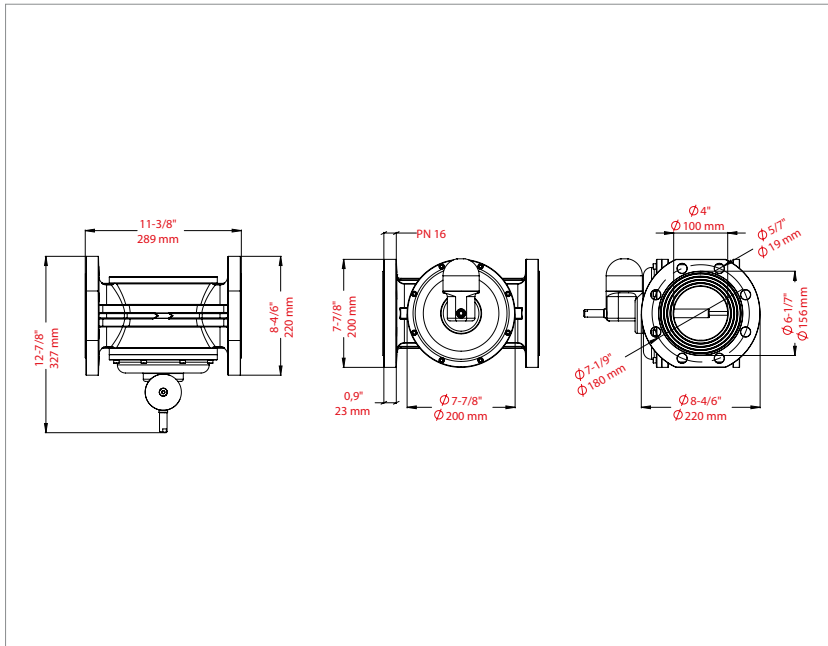

MODEL	PIPE SIZE	DN	PN	NORM	POSITION	TEMP. RANCE	Max. PRESSURE	WEIGHT
FDV 1003	4"	100	16	DIN	Horizontal	-23°C(-10°F) to +66°C (+150°F)	4 bar / 60 PSI	22,660 lb / 10,3 kg

Material	Min. Turning Effort	Min. Bending Moment	CV	Eqv Lenght of pipe (ft)
Aluminium Alloy / Brass / Stainless Steel	1500 lnc lbf / 169,5 Nm	200,0 Lb / 90,7 kg	189	6,5

FLOW CAPACITY TABLE IWC/PSIG - Capacity S.C.F.H

Pressure Drop		Inlet Pressure (iwc)		Inlet Pressure (psi)					
psi	iwc	8" iwc	14" iwc	3	5	7	10	20	60
0.0036	0.1	3270	3293	3553	3748	3934	4197	4975	7300
0.0072	0.2	4623	4657	5024	5301	5563	5935	7035	10323
0.0108	0.3	5662	5702	6153	6491	6813	7269	8616	12643
0.0144	0.4	6537	6584	7104	7495	7866	8393	9948	14598
0.018	0.5	7307	7360	7941	8379	8794	9383	11122	16321
0.0216	0.6	8004	8062	8699	9177	9633	10277	12183	17878
0.0252	0.7	8644	8706	9395	9912	10403	11100	13158	19310
0.0288	0.8	9240	9307	10042	10595	11121	11866	14066	20643
0.0324	0.9	9799	9870	10650	11237	11794	12584	14919	21895
0.036	1.0	10328	10403	11225	11844	12431	13264	15725	23078
0.072	2.0	14588	14694	15859	16734	17566	18745	22227	32630
0.108	3.0	17845	17975	19403	20476	21496	22941	27208	39954
0.144	4.0	20581	20731	22382	23622	24801	26470	31401	46123
0.18	5.0	22983	23150	24998	26386	27705	29573	35089	51555

FLOW CAPACITY TABLE IWC/PSIG - Capacity m³/h

Pressure Drop		Inlet Pressure (iwc)		Inlet Pressure (psi)					
psi	iwc	8" iwc	14" iwc	3	5	7	10	20	60
0.0036	0.1	91,56	92,20	99,48	104,94	110,15	117,52	139,30	204,40
0.0072	0.2	129,44	130,40	140,67	148,43	155,76	166,18	196,98	289,04
0.0108	0.3	158,54	159,66	172,28	181,75	190,76	203,53	241,25	354,00
0.0144	0.4	183,04	184,35	198,91	209,86	220,25	235,00	278,54	408,74
0.018	0.5	204,60	206,08	222,35	234,61	246,23	262,72	311,42	456,99
0.0216	0.6	224,11	225,74	243,57	256,96	269,72	287,76	341,12	500,58
0.0252	0.7	242,03	243,77	263,06	277,54	291,28	310,80	368,42	540,68
0.0288	0.8	258,72	260,60	281,18	296,66	311,39	332,25	393,85	578,00
0.0324	0.9	274,37	276,36	298,20	314,64	330,23	352,35	417,73	613,06
0.036	1.0	289,18	291,28	314,30	331,63	348,07	371,39	440,30	646,18
0.072	2.0	408,46	411,43	444,05	468,55	491,85	524,86	622,36	913,64
0.108	3.0	499,66	503,30	543,28	573,33	601,89	642,35	761,82	1118,71
0.144	4.0	576,27	580,47	626,70	661,42	694,43	741,16	879,23	1291,44
0.18	5.0	643,52	648,20	699,94	738,81	775,74	828,04	982,49	1443,54

FLOW CAPACITY TABLE IWC/PSIG - Capacity kW

Pressure Drop		Inlet Pressure (iwc)		Inlet Pressure (psi)					
psi	iwc	8" iwc	14" iwc	3	5	7	10	20	60
0.0036	0.1	965,96	972,75	1049,56	1107,16	1162,10	1239,79	1469,62	2156,42
0.0072	0.2	1365,63	1375,68	1484,09	1565,92	1643,31	1753,20	2078,14	3049,41
0.0108	0.3	1672,55	1684,37	1817,60	1917,44	2012,56	2147,26	2545,17	3734,74
0.0144	0.4	1931,03	1944,91	2098,52	2214,02	2323,62	2479,29	2938,64	4312,25
0.018	0.5	2158,49	2174,14	2345,77	2475,16	2597,75	2771,74	3285,44	4821,22
0.0216	0.6	2364,38	2381,51	2569,68	2710,89	2845,59	3035,83	3598,86	5281,16
0.0252	0.7	2553,44	2571,75	2775,28	2928,00	3073,05	3278,94	3886,87	5704,17
0.0288	0.8	2729,50	2749,29	2966,41	3129,76	3285,14	3505,22	4155,10	6097,94
0.0324	0.9	2894,62	2915,60	3146,01	3319,41	3483,95	3717,31	4407,07	6467,78
0.036	1.0	3050,89	3073,05	3315,87	3498,72	3672,12	3918,19	4645,17	6817,24
0.072	2.0	4309,30	4340,61	4684,75	4943,22	5189,00	5537,27	6565,86	9638,90
0.108	3.0	5271,41	5309,82	5731,65	6048,61	6349,92	6776,77	8037,24	11802,41
0.144	4.0	6079,63	6123,94	6611,64	6977,94	7326,22	7819,24	9275,86	13624,73
0.18	5.0	6789,18	6838,51	7384,41	7794,42	8184,06	8735,86	10365,29	15229,35

CERTIFICATES	TUV Austria CE 0408 (Products Approval Standard ASCE 25-16 and TS 12884)
APPLICATION	Gasses : Natural Gas, LPG, methane, propane, air, etc... non corrosive gaseous fluids.
INFORMATION	Experiments were carried out with air. Calculations based on gas with a density of 0.64 and a calorific value of 37 MJ/m ³ . The measured flow value is arranged according to 15 °C and 101.3 kPa pressure.

