

FDV 802 MECHANICAL EARTQUAKE VALVE

3" Flanged Vertical

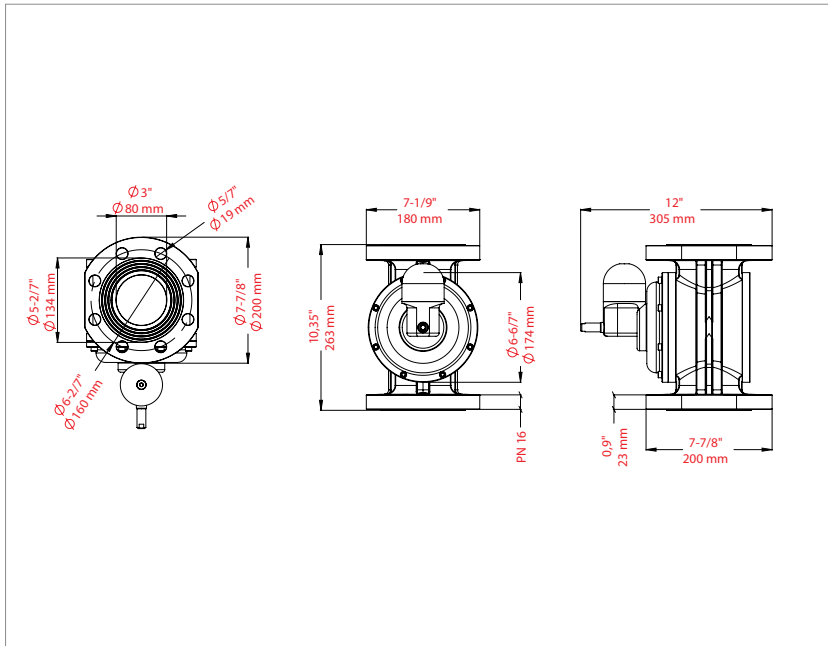

MODEL	PIPE SIZE	DN	PN	NORM	POSITION	TEMP. RANCE	Max. PRESSURE	WEIGHT
FDV 802	3"	80	16	DIN	Vertical	-23°C(-10°F) to +66°C(+150°F)	4 bar / 60 PSI	18,271 lb / 8,305 kg

Material	Min. Turning Effort	Min. Bending Moment	CV	Eqv Lenght of pipe (ft)
Aluminium Alloy / Brass / Stainless Steel	1310 Inc lbf / 148,0 Nm	200,0 Lb / 90,7 kg	142	3,4

FLOW CAPACITY TABLE IWC/PSIG - Capacity S.C.F.H

Pressure Drop		Inlet Pressure (iwc)		Inlet Pressure (psi)					
psi	iwc	8" iwc	14" iwc	3	5	7	10	20	60
0.0036	0.1	2470	2487	2684	2831	2971	3170	3758	5513
0.0072	0.2	3492	3517	3795	4004	4202	4483	5314	7797
0.0108	0.3	4276	4307	4647	4903	5146	5490	6508	9549
0.0144	0.4	4937	4973	5366	5661	5941	6339	7514	11026
0.018	0.5	5519	5559	5998	6328	6642	7087	8401	12327
0.0216	0.6	6045	6089	6570	6932	7276	7763	9202	13504
0.0252	0.7	6529	6576	7096	7487	7858	8384	9939	14585
0.0288	0.8	6979	7029	7585	8003	8400	8962	10624	15592
0.0324	0.9	7401	7455	8044	8487	8908	9505	11268	16537
0.036	1.0	7801	7857	8479	8946	9390	10019	11877	17431
0.072	2.0	11019	11099	11978	12640	13268	14158	16788	24646
0.108	3.0	13479	13577	14655	15466	16236	17327	20551	30178
0.144	4.0	15545	15658	16905	17842	18732	19993	23718	34838
0.18	5.0	17359	17486	18881	19930	20926	22337	26503	38940

FLOW CAPACITY TABLE IWC/PSIG - Capacity m³/h

Pressure Drop		Inlet Pressure (iwc)		Inlet Pressure (psi)					
psi	iwc	8" iwc	14" iwc	3	5	7	10	20	60
0.0036	0.1	69,16	69,64	75,15	79,27	83,19	88,76	105,22	154,36
0.0072	0.2	97,78	98,48	106,26	112,11	117,66	125,52	148,79	218,32
0.0108	0.3	119,73	120,60	130,12	137,28	144,09	153,72	182,22	267,37
0.0144	0.4	138,24	139,24	150,25	158,51	166,35	177,49	210,39	308,73
0.018	0.5	154,53	155,65	167,94	177,18	185,98	198,44	235,23	345,16
0.0216	0.6	169,26	170,49	183,96	194,10	203,73	217,36	257,66	378,11
0.0252	0.7	182,81	184,13	198,69	209,64	220,02	234,75	278,29	408,38
0.0288	0.8	195,41	196,81	212,38	224,08	235,20	250,94	297,47	436,58
0.0324	0.9	207,23	208,74	225,23	237,64	249,42	266,14	315,50	463,04
0.036	1.0	218,43	220,00	237,41	250,49	262,92	280,53	332,56	488,07
0.072	2.0	308,53	310,77	335,38	353,92	371,50	396,42	470,06	690,09
0.108	3.0	377,41	380,16	410,34	433,05	454,61	485,16	575,43	844,98
0.144	4.0	435,26	438,42	473,34	499,58	524,50	559,80	664,10	975,46
0.18	5.0	486,05	489,61	528,67	558,04	585,93	625,44	742,08	1090,32

FLOW CAPACITY TABLE IWC/PSIG - Capacity kW

Pressure Drop		Inlet Pressure (iwc)		Inlet Pressure (psi)					
psi	iwc	8" iwc	14" iwc	3	5	7	10	20	60
0.0036	0.1	729,64	734,66	792,85	836,28	877,63	936,42	1110,11	1628,54
0.0072	0.2	1031,54	1038,92	1121,04	1182,78	1241,27	1324,28	1569,76	2303,23
0.0108	0.3	1263,13	1272,29	1372,72	1448,35	1520,13	1621,75	1922,46	2820,77
0.0144	0.4	1458,39	1469,02	1585,12	1672,26	1754,97	1872,54	2219,64	3257,08
0.018	0.5	1630,31	1642,13	1771,81	1869,29	1962,05	2093,50	2481,66	3641,40
0.0216	0.6	1785,69	1798,69	1940,78	2047,71	2149,33	2293,19	2718,27	3989,08
0.0252	0.7	1928,67	1942,55	2096,16	2211,66	2321,25	2476,63	2935,98	4308,41
0.0288	0.8	2061,60	2076,37	2240,61	2364,09	2481,36	2647,37	3138,33	4605,88
0.0324	0.9	2186,26	2202,21	2376,20	2507,06	2631,42	2807,78	3328,57	4885,03
0.036	1.0	2304,42	2320,96	2504,70	2642,65	2773,81	2959,61	3508,47	5149,12
0.072	2.0	3255,01	3278,64	3538,30	3733,86	3919,37	4182,27	4959,18	7280,43
0.108	3.0	3981,70	4010,65	4329,09	4568,66	4796,11	5118,40	6070,77	8914,58
0.144	4.0	4591,99	4625,37	4993,74	5270,53	5533,43	5905,93	7006,30	10291,15
0.18	5.0	5127,85	5165,36	5577,45	5887,32	6181,54	6598,35	7828,99	11502,88

CERTIFICATES	TUV Austria CE 0408 (Products Approval Standard ASCE 25-16 and TS 12884)
APPLICATION	Gasses : Natural Gas, LPG, methane, propane, air, etc... non corrosive gaseous fluids.
INFORMATION	Experiments were carried out with air. Calculations based on gas with a density of 0.64 and a calorific value of 37 MJ/m ³ . The measured flow value is arranged according to 15 °C and 101.3 kPa pressure.

